



T-type Hinge

2017

Important Information

Technical information

While every effort has been made in the production of this catalogue to ensure the accuracy of information, our products are continually being revised and users should confirm the up to date specification before ordering. Due to constant improvement of products presented in the catalogue, we can make changes at any time and without notice.

Responsibility

It is the responsibility of the user to ensure the fitness of hardware for the intended purpose. We recommend assessment by appropriate testing in the application and by technical enquiry to our representatives.

Intellectual property

Titus Group owns the intellectual property rights in its products worldwide whether as trademarks, patents, intellectual, copyright, designs, illustrations, drawings and the 'know how' contained in their design and production. Titus Group respects the equivalent rights in competitors and all other relevant product design rights. To our knowledge our products do not infringe any intellectual property rights of competitors or other parties. Titus Group takes infringements of its rights seriously and will rigorously defend these rights to the full extent of the law.

***Non preferred articles**

All Item numbers in the catalogue marked with * are for non preferred items available on extended delivery times.

Trademarks

Titus and Titusonic are registered trademarks of Titus International Ltd. Lama is a registered trademark of Titus d.o.o. Dekani, WoodWelding is a registered trademark of WW SA.

Titus Hinges

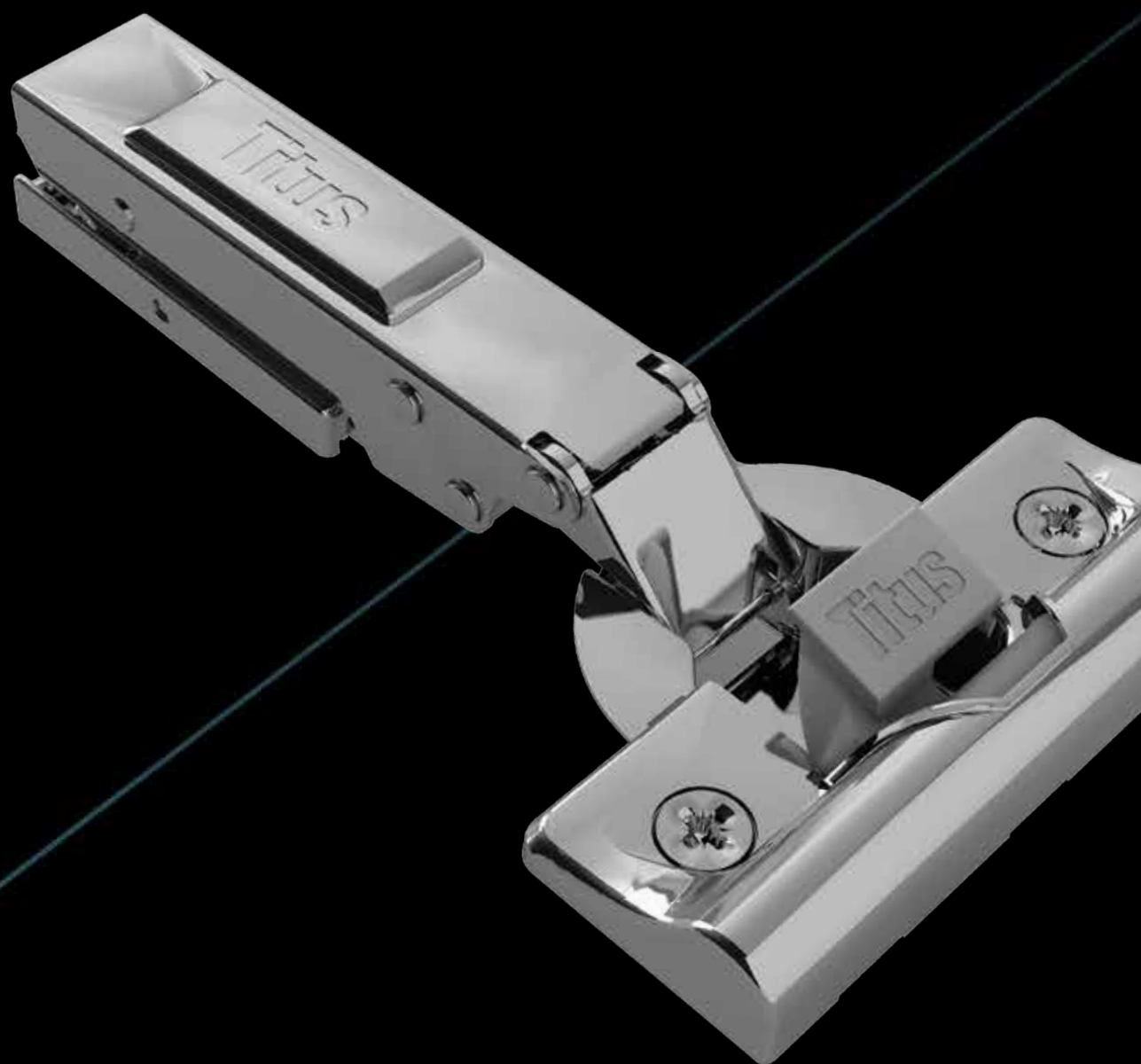

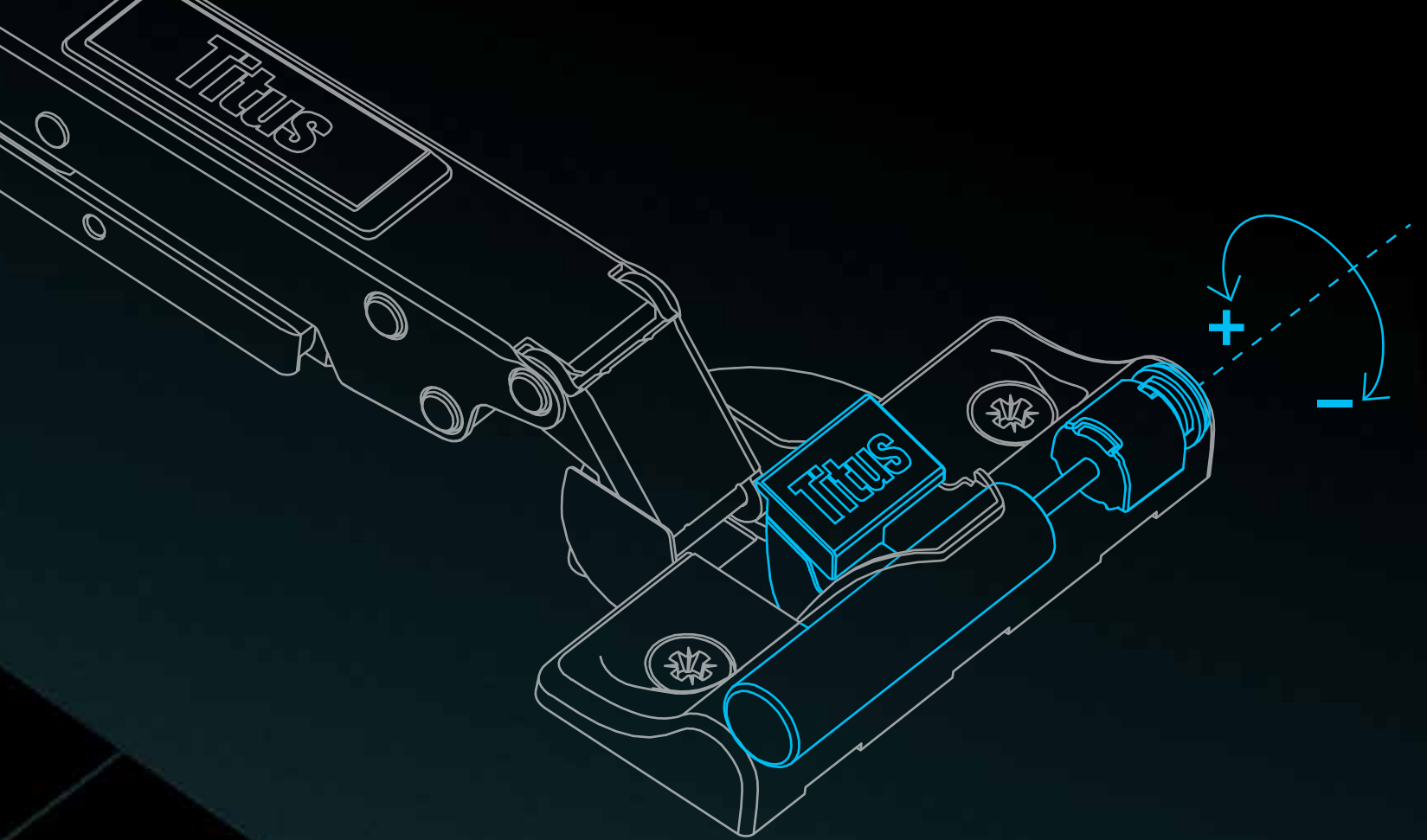

'ConfidentClose'

The hinge is designed to deliver consumer preferred soft closing motion.

- Fast closing
- Late start of deceleration action
- Quiet landing with 'SoftTouch'

Based on third party consumer research.

'One-for-All'

- Damping on the hinge cup
- Positioning of dampers transverse to the hinge cup allows for consistent damping across hinge variations
- Universal mounting plate for both damped and non-damped hinges

Adjustable Damping

Flexibility to tune performance to a wide range of applications

- Consistent performance over a wide range of doors of different sizes and weights
- Easy accessible button for intuitive and quick adjustment

Titus Damper Inside

- Efficient damping at any closing speed
- Reliable closing
- Damping force consistency

A new generation hinge

T-type hinge



Titus New Generation hinge for quick furniture assembly and consistent performance on a wide range of doors

- '3Way' snap-on mounting
- Highly tolerant
- Adjustable damping
- 'ConfidentClose'

Numerous application possibilities

- for simpler cabinet design
- for demanding high quality furniture of larger heights and weights

Opening angle	Door thickness	Crankings	Door tab K	Mounting mode	Mounting plate type	Mounting plate height	Soft closing options	Durability (cycles)
110° 170°	15-26mm	0mm 9mm 17mm angled	3-6mm	'3Way' snap-on	cruciform linear for face frame	0mm 1mm 2mm 3mm 4mm	Damping integrated in the hinge cup Glissando add-on or stand-alone damping solutions	1000,000

T-type Hinges

Product Guide

	Cranking	Opening angle	Cup type	Page
T-type hinge				
T-type Glissando 110	0mm	110°	for wood door	21
	9mm	110°	for wood door	23
	17mm	110°	for wood door	23
T-type Glissando 110/45°	45°, 17mm	110°	for wood door	25
T-type Glissando 110/90°	90°, 17mm	110°	for wood door	27
T-type 110	0mm	110°	for wood door	29
	9mm	110°	for wood door	31
	17mm	110°	for wood door	31
T-type 110/45°	45°, 17mm	110°	for wood door	33
T-type 110/90°	90°, 17mm	110°	for wood door	35
T-type 170	0mm	170°	for wood door	37
	9mm	170°	for wood door	39
T-type mounting plates				41

Accessories

Push latch

See complete Technical Catalogue 1.109

Cover caps

See complete Technical Catalogue 1.111

Glissando soft closing systems

	Mounting type	Hinge type	Hinge opening angle	page
Glissando TT	Add-on	T-type	110°	55
Glissando TT 170	Add-on	T-type	170°	57
Glissando CR	Stand-alone	T-type	110°	59

T-type Hinges

Door Overlay

How to Achieve the Desired Door Overlay

Choose the hinge of appropriate cranking

Concealed hinges with specific hinge arms are available for different door overlays. The most common overlays are:

■ Cabinet side
■ Door

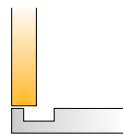

- 1. Full overlay**
Use a hinge with 0mm cranking

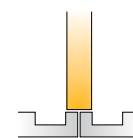

- 2. Partial overlay for double doors**
Use a hinge with 5mm or 9mm cranking

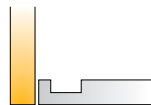

- 3. Inset door**
Use a hinge with 15mm or 17mm cranking

Choose the mounting plates of appropriate thickness

To achieve the desired overlay (x) while using a determined drilling distance (K), a mounting plate of appropriate

thickness (D) must be chosen from the enclosed table or calculated with the given formula.

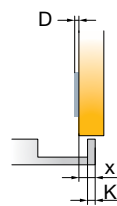

x	4	5	6	7	8	9
D	3	2	1	0		
K	4	3	2	1	0	
D	5		3	2	1	0

$$D=4+K-x$$

Choose the appropriate drilling distance K

To achieve the desired door overlay (x) while using a determined mounting plate thickness (D), an appropriate drilling distance K must be chosen.

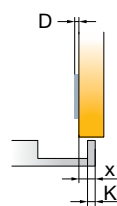

x	4	5	6	7	8	9
D	0			3	4	5
D	1		3	4	5	
D	2	3	4	5		
D	3	3	4	5		

Through side adjustment

The side adjustment is made by rotating the appropriate screw on the hinge arm.

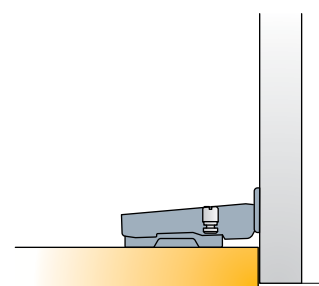
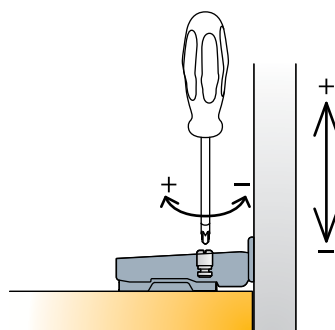
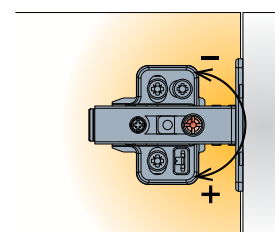

Adjustment range

Door clearance and gap

The door clearance ($F \geq F_{min}$) and gap (Z) represent the minimal necessary space needed for the correct opening and closing of the door. The minimal required values depend on the cup drilling distance (K), door thickness (V)

and the type of hinge. The minimum clearance scale can be found on product pages > see *Door clearance chart*. When using hinges with partial overlay the door clearance must be twice as large ($F \geq 2F_{min}$).

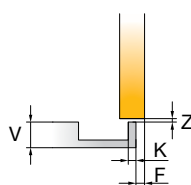

V	16	17	18	19	20	21	22
3	0.3	0.5	0.7	1.0	1.3	1.7	2.5
K 4	0.3	0.5	0.7	0.9	1.2	1.6	2.1
5	0.3	0.5	0.7	0.9	1.2	1.5	2.0 F_{min}

Gap $Z_{min}=0$

T-type Hinges

Hinge Cup Types

How to Mount the Hinge on the Door

There are cup type symbols listed on product pages beside item numbers. Below you can find their explanation.

No premounting

The hinge is fixed on the door with two screws. 3mm pilot holes recommended.

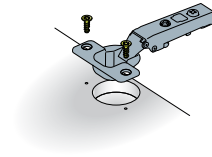

'Easy-Fix' time saving system

Quarter turn fixing for 8mm holes (interaxis 45/9.5) or 10mm holes (interaxis 48/6 and 52/5.5).

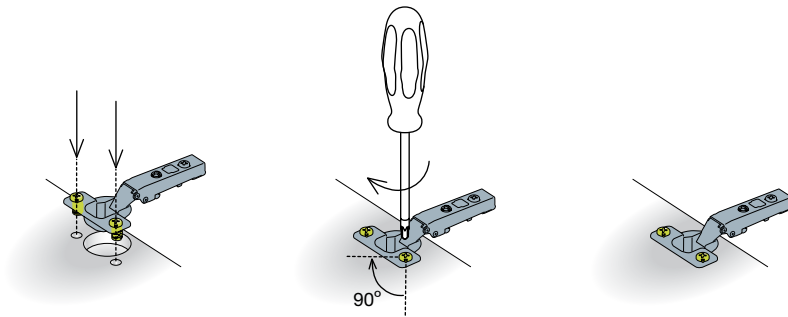

Machine insertion ready hinge cup

Premounted dowels suitable for machine insertion into 8mm holes (interaxis 45/9.5) or 10mm holes (interaxis 48/6 and 52/5.5).

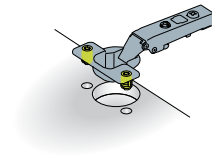

Premounted expando dowels

Premounted expanding dowels with triple-start screw for fast fixing, suitable for 8mm holes.

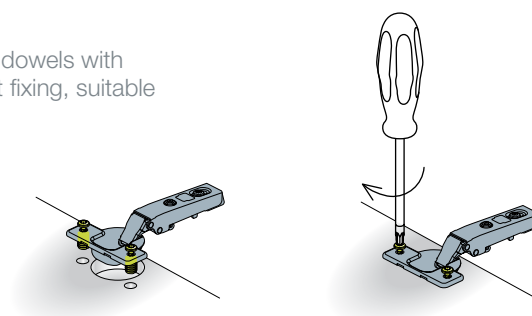



Hinge cup with
premounted euro screws

Premounted euro screws for 5mm holes.
Where not specified otherwise, euro
screws are 13mm long.

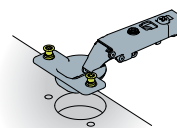

Hinge cup with
premounted
chipboard screws

Premounted chipboard screws.
3mm pilot holes recommended.

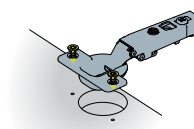

Aluminium frame
screw-on hinge cup

The hinge is fixed onto a specific drilling
on the aluminium frame.

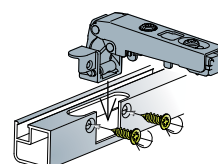











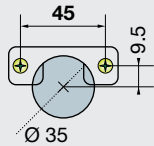
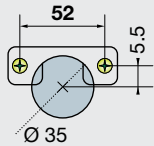

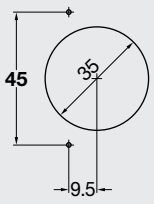
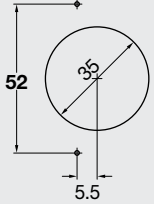
T-type Hinges

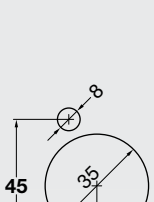
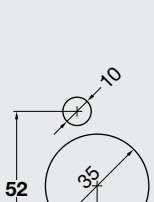
Boring Details

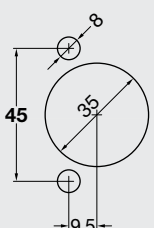
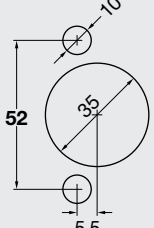
Drilling Patterns for Hinge Cup

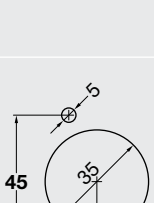
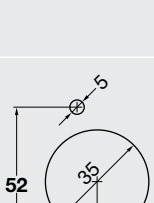
Interaxis
45mm and 52mm

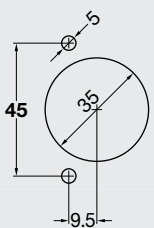
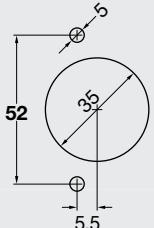
· T-type

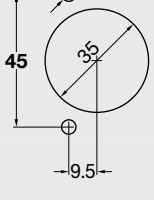
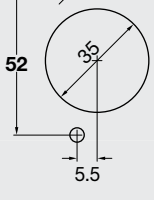
	Interaxis 45mm	Interaxis 52mm
Hinge cup type		
 Screw-on ready		
 Premounted chipboard screws		
 Machine insertion ready		
 Premounted expando dowels		
 Easy-fix system		
 Premounted euro screws		

Interaxis is the distance between two holes for fixing screws on the hinge cup.

T-type Hinges

Mounting Plate Type

How to Fix the Mounting Plate on the Cabinet Side

There are mounting plate type symbols listed on product pages beside item numbers. Below you can find their explanation.



No Premounting, chipboard screw ready

The mounting plate is fixed with two chipboard screws or equivalent. 3mm pilot holes recommended.

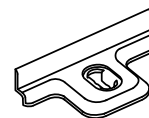

No Premounting, euro screw ready

Fixing with 6.3mm euro screws into pre-drilled 5mm holes. Choosing the appropriate head and length for use with this mounting plate is recommended.

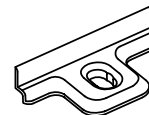

Machine insertion ready

Premounted dowels for machine insertion into 10mm holes.

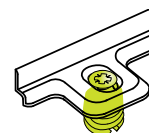

Premounted euro screws

Euro screws for 5mm holes are premounted on the mounting plate. Available lengths: 11mm, 13mm and 15mm.

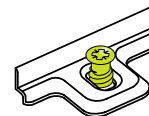

Premounted expanding dowels

Premounted expanding dowels for 5mm holes. Available lengths: 7.5mm and 10.5mm.

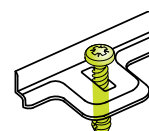

Premounted chipboard screws

The mounting plate is fixed with two premounted chipboard screws. 3mm pilot holes recommended.

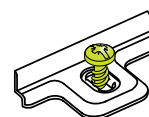

T-type Hinges

Hinge-to-plate Mounting

How to Assemble the Hinge and the Mounting Plate

T-type
'3Way' snap-on

'3Way' snap-on mounting for intuitive hinge-to-plate assembly in three directions:

- from the hinge arm front
- from the hinge arm rear
- from the top

front assembly

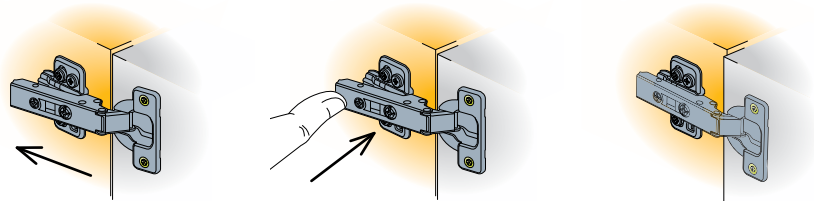

rear assembly

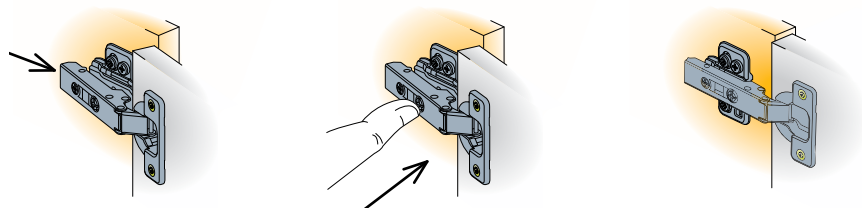

top assembly



disassembly:
for disassembly press rear
button on the hinge arm.

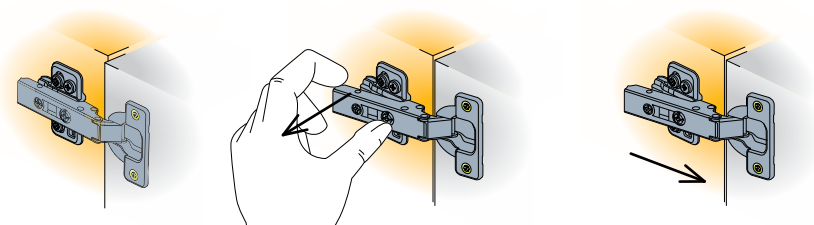

T-type Hinges Loadings



Use the appropriate number of hinges so that the door height or weight does not exceed that shown below.

How Many Hinges per Door

Check the enclosed specifications for the number of required hinges per door by considering door height and weight.

Concealed hinges with
Ø 35mm hinge cup diameter

- T-type

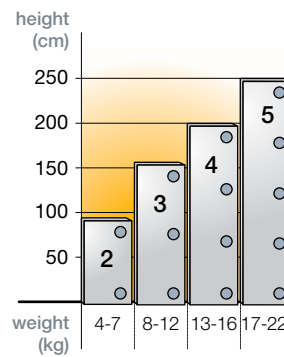

- T-type Glissando

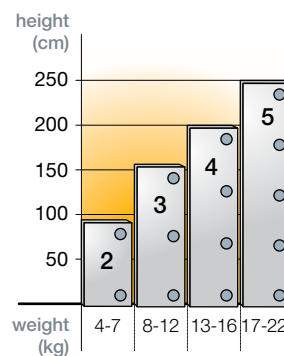

Hinges with integrated damping can be combined with non-damped hinges from standard hinge range. A trial mounting is always recommended.

T-type Hinges Adjustment



Adjustment range can be found on the product pages.

Side Adjustment

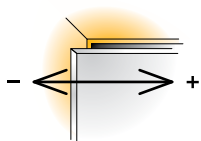

The side adjustment aligns the door with the side of the cabinet.

Rotate the appropriate screw

- T-type

The side adjustment is made by rotating the screw on the hinge arm.

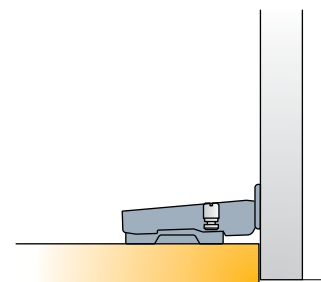
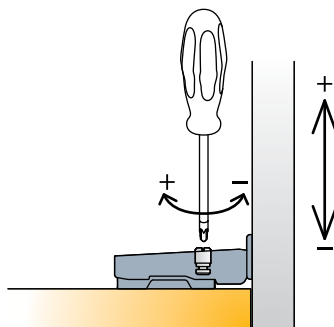
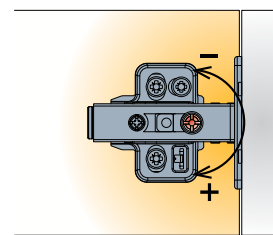

Adjustment range

T-type Hinges Adjustment

Height Adjustment

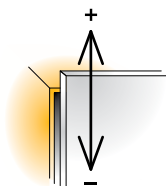

Height adjustment is necessary to achieve optimal vertical door position.

Rotate the cam adjuster

The height adjustment is made by rotating the cam adjuster on the mounting plate.

- T-type with cam adjustable cruciform mounting plate

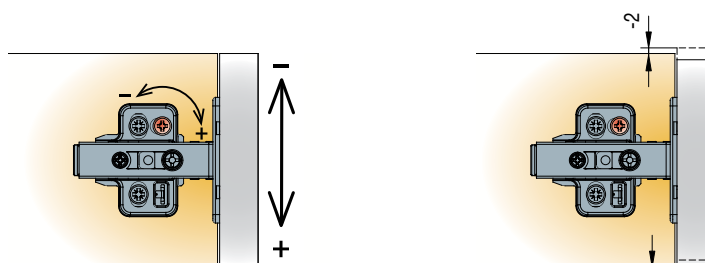

- T-type with cam adjustable linear mounting plate

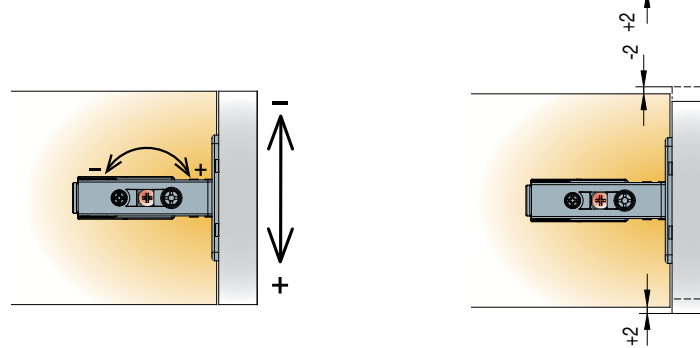

Release the screw slot

- T-type with cruciform mounting plate

For height adjustment, the two mounting plate fixing screws have to be temporarily released while making the manual adjustment.

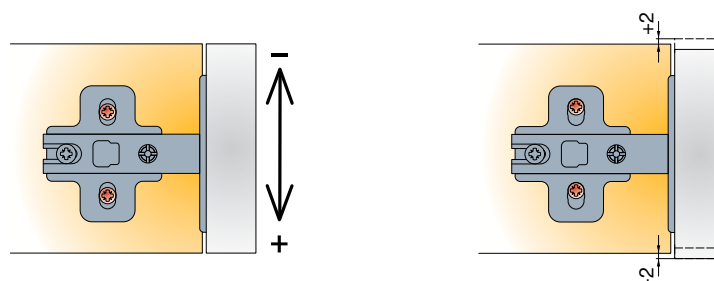

T-type Hinges Adjustment

Depth Adjustment

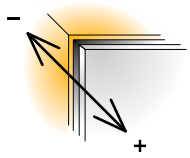

The system enables easy adjustment of the gap between door and cabinet.

Rotate the cam adjuster

Rotate the cam adjuster on the hinge arm.

· T-type

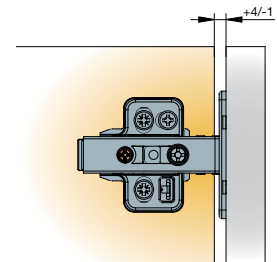
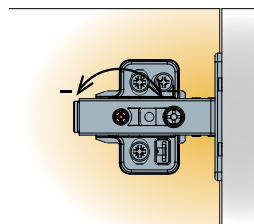

Titus
recommends!

Most of Titus hinges can be combined
with soft closing devices.
→ see pages 49 - 60 for details

Door Closing Type

There are two door
closing systems:

self-closing ←
free-swinging -----

Concealed hinges with
self-closing angle

- T-type

The self-closing angle is the point
from which the door will close by
itself, without user assistance. The
mechanism starts closing the door from
a 14° to 25° angle, depending on the
concealed hinge type. From that point
to the maximum opening angle the door
remains in an open position.

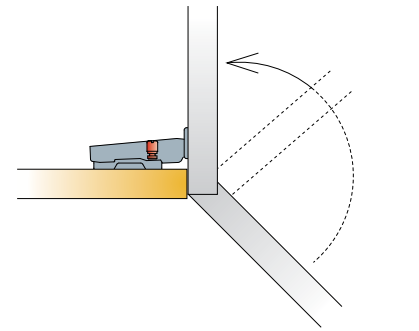

Free-swinging door hinges*

Optionally most of Titus concealed
hinges can be supplied without self-
closing mechanism. These hinges may
be ordered upon request. Soft closing
devices can not be used with free-
swinging door hinges.

** Available upon special request, speak to your
Technical Sales Representative.*

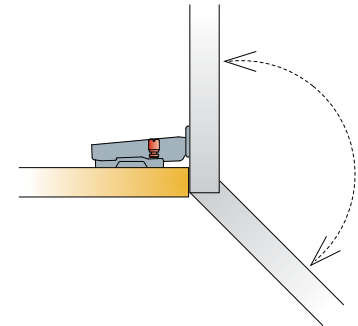

Concealed Hinges Adjustment

Damping Adjustment

T-type Glissando

The damping action can be adjusted to fit different door weights and sizes which enables perfect door functioning.

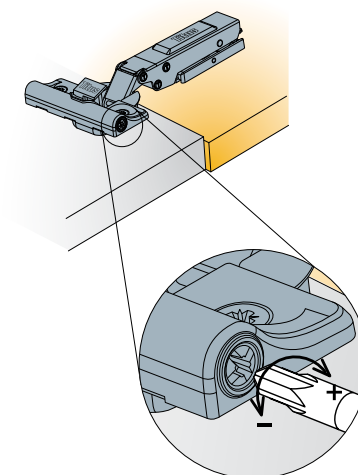

Damping is factory pre-set to the medium damping value.
Turn towards '+' to increase and '-' to decrease the damping.

Key Design Choices

'ConfidentClose'

The hinge is designed to deliver consumer-preferred soft closing motion.

Based on results of third party research

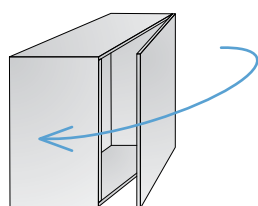

Fast closing

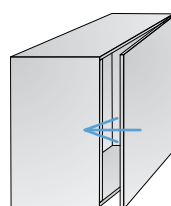

Late start of deceleration action

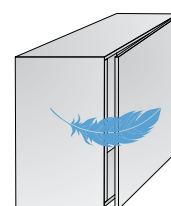

Quiet landing with 'SoftTouch'

'One-for-all' efficiency principle

Positioning of damper transversal to the hinge cup allows for consistent damping across hinge variations.

Universal mounting plate platform for both damped and non-damped hinges.



Adjustable damping

Flexibility to tune performance for all applications

- Consistent performance over a wide range of doors of different sizes and weights
- Easy accessible adjustment button for intuitive and quick adjustment

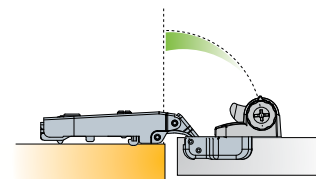

Adjustable damping zone and force

Titus Damper Inside

- Efficient damping at any closing speed
- Reliable closing
- Damping force consistency



T-type Hinges

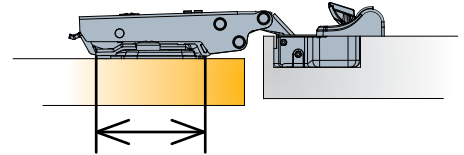
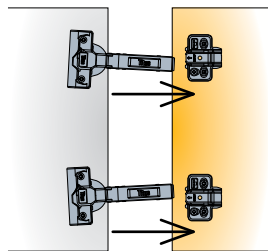
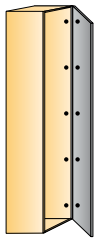
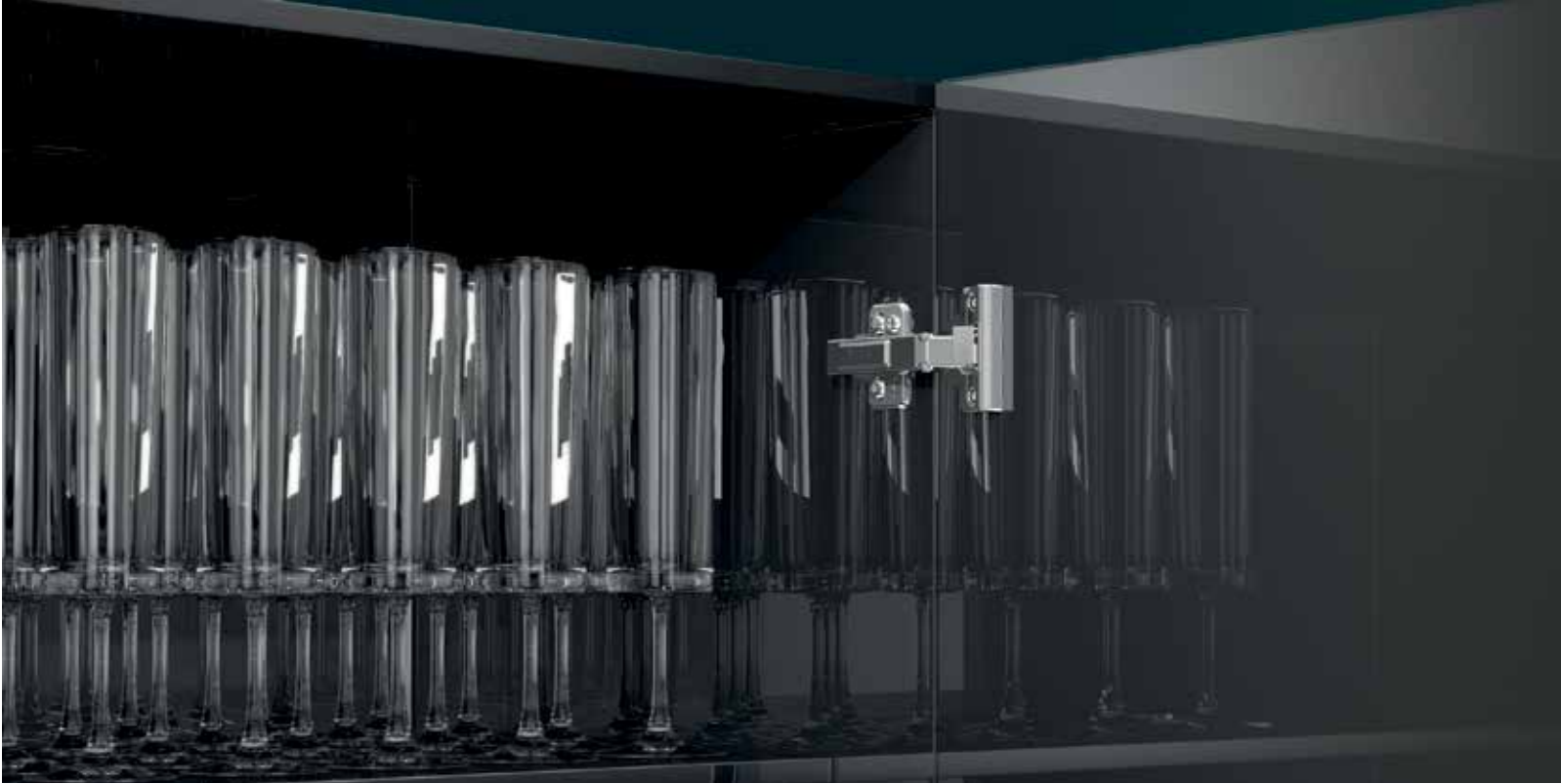

Easy door installation even in cases of 4-5 hinges per door

- Easy and quick assembly and disassembly
- Flexibility for the furniture user
- Tight hinge-to-plate joint improves hinge stability and reduces door sag

Highly tolerant

- Efficient performance in marginal values of tolerances
- Reliable door closing in case of accidental misalignment
- 'ConfidentClose' assured

Rigidity

- Hinge-to-plate attachment assures stability and rigidity
- Smooth performance

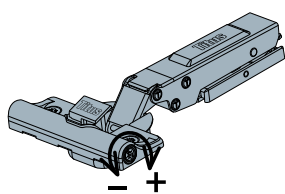

Adjustable damping

- Consistent performance on doors of different dimensions and weights
- Intuitive adjustment procedure



'Titus Damper Inside'

- Titus proprietary multi-purpose damping technology
- Reliable and consistent life-long damping
- No rebound



Proven Glissando concept

- Damper is positioned transversal on the hinge cup
- Reliable performance

T-type Glissando 110

For wood doors

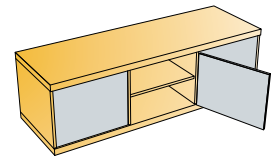
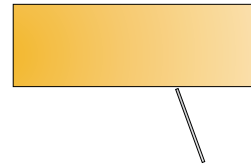
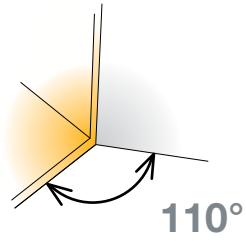

- Opening angle
- Drilling diameter for hinge cup
- Drilling depth
- Hinge on plate mounting system

- 110°
- 35mm
- 11.7mm
- '3Way' snap-on



Technical details

Cup type	Interaxis 45mm	Interaxis 52mm
	Item number	Item number
	701.0AT0.054.00	
	701.0AT1.054.00	701.0AP1.054.00
	701.0AT4.054.00	701.0AP4.054.00

Cranking
0mm

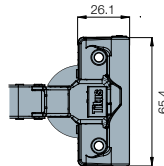
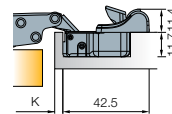
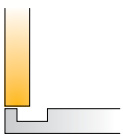

Drilling patterns for hinge cups → see page 9

Made of steel

Mounting plates

- Cam adjustable cruciform mounting plate → see page 41
- Cruciform mounting plate → see page 43
- Cam adjustable linear mounting plate → see page 41
- Face frame adapter plate → see page 43

Hinge cup screws

If not premounted

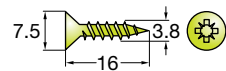

611.8K16.338.016
1,000 Pcs

Accessories



Cover caps for hinge arm → see complete catalogue page 1.111

Legend of hinge cup symbols

- Screw-on ready ← screws
- Machine insertion ready
- EasyFix system

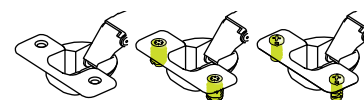

Damping adjustment

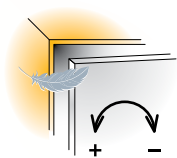

For further explanation → see page 19

Door adjustment

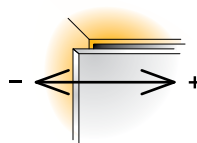

Side adjustment
+3/-1mm

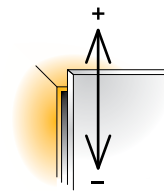

Height adjustment
+2/-2mm

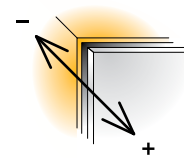

Depth adjustment
+4/-1mm

For further explanation → see pages 14-17

Mounting details

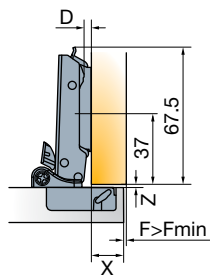
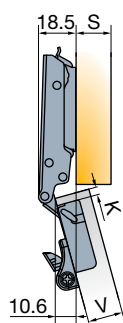

Mounting plate drilling distance

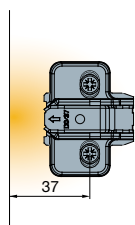

Mounting plate thickness table

For further explanation → see page 5

x	13	14	15	16	17	18	19
3	3	2	1	0			
4	4	3	2	1	0		
K							
5		4	3	2	1	0	
6			4	3	2	1	0

$D=13+K-x$

Drawings show application on D=0mm thick mounting plate

Door clearance at R=1mm

For further explanation → see page 5

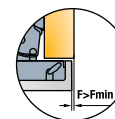

V	16	17	18	19	20	21	22	23	24	25	26
3	0.5	0.7	0.8	1	1.2	1.5	1.7	2.1	2.8	4.1	5.5
4	0.4	0.7	0.8	1	1.2	1.5	1.7	2.1	2.3	3.1	4.5
K											
5	0.4	0.6	0.7	0.9	1.1	1.4	1.6	2	2.2	2.6	3.5
6	0.4	0.6	0.7	0.9	1.1	1.4	1.6	2	2.2	2.6	2.9

Gap $Z_{MIN}=0$

T-type Glissando 110

For wood doors

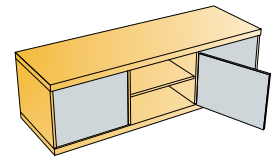
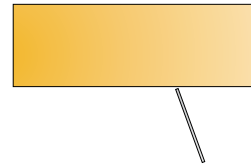
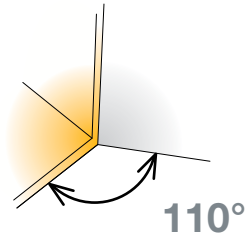

- Opening angle
- Drilling diameter for hinge cup
- Drilling depth
- Hinge on plate mounting system

110°
35mm
11.7mm
'3Way' snap-on



Technical details

Cup type	Interaxis 45mm	Interaxis 52mm
Item number		Item number

Cranking
9mm

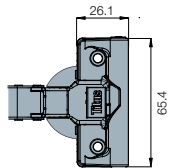
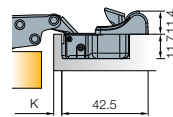
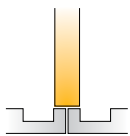

Made of steel

	701.OCT0.054.00	
	701.OCT1.054.00	701.OCP1.054.00
	701.OCT4.054.00	701.OCP4.054.00

Drilling patterns for hinge cups → see page 9

Cranking
17mm

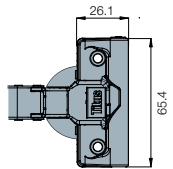
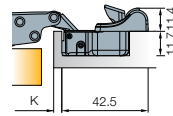
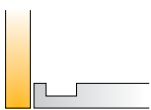

Made of steel

	701.ODT0.054.00	
	701.ODT1.054.00	701.ODP1.054.00
	701.ODT4.054.00	701.ODP4.054.00

Drilling patterns for hinge cups → see page 9

Mounting plates



Cam adjustable cruciform mounting plate
→ see page 41



Cruciform mounting plate
→ see page 43



Cam adjustable linear mounting plate
→ see page 41



Face frame adapter plate
→ see page 43

Hinge cup screws

If not premounted

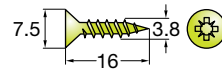

611.8K16.338.016

1,000 Pcs

Accessories



Cover caps for hinge arm
→ see complete catalogue page 1.111

Legend of hinge cup symbols

Screw-on ready
← screws

Machine insertion ready

EasyFix system

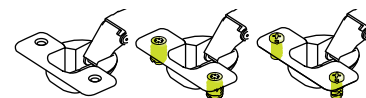

Damping adjustment

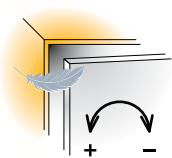

Door adjustment

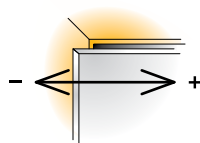

Side adjustment
+3/-1mm

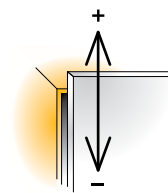

Height adjustment
+2/-2mm

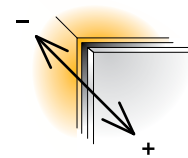

Depth adjustment
+4/-1mm

For further explanation → see page 19

For further explanation → see pages 14-17

Mounting details

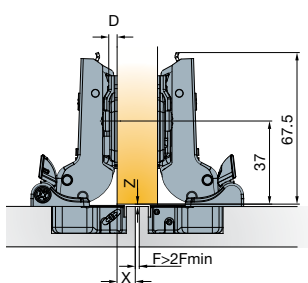
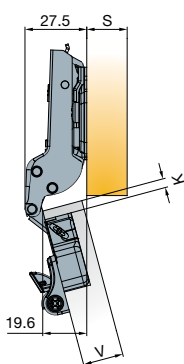

Mounting plate drilling distance

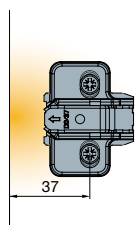

Mounting plate thickness table
For further explanation → see page 5

x	4	5	6	7	8	9	10
3	3	2	1	0			
4	4	3	2	1	0		
5		4	3	2	1	0	
6			4	3	2	1	0

$D=4+K-x$

Drawings show application on D=0mm thick mounting plate

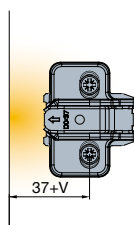
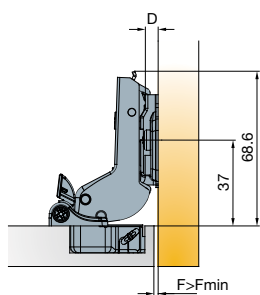
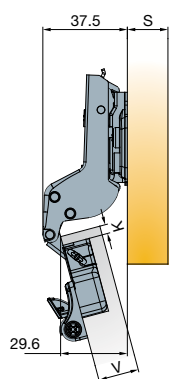

V

V	16	17	18	19	20	21	22	23	24
3	0	0	0	0	1	1	1	1	2
4	1	1	1	1	2	2	2	2	3
5	2	2	2	2	3	3	3	3	4
6	3	3	3	3	4	4	4	4	D

$D=4+K+F$

Drawings show application on D=2mm thick mounting plate

Door clearance at R=1mm

For further explanation → see page 5

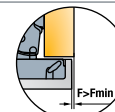

V	16	17	18	19	20	21	22	23	24	25	26
3	0.5	0.7	0.8	1	1.2	1.5	1.7	2.1	2.8	4.1	5.5
4	0.4	0.7	0.8	1	1.2	1.5	1.7	2.1	2.3	3.1	4.5
5	0.4	0.6	0.7	0.9	1.1	1.4	1.6	2	2.2	2.6	3.5
6	0.4	0.6	0.7	0.9	1.1	1.4	1.6	2	2.2	2.6	2.9 F _{MIN}

Gap Z_{MIN}=0

T-type Glissando 110/45°

45° angled application for wood doors

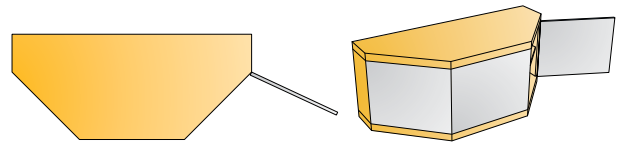
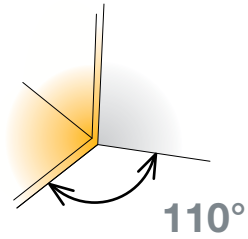

- Opening angle 110°
- Drilling diameter for hinge cup 35mm
- Drilling depth 11.7mm
- Hinge on plate mounting system '3Way' snap-on



Technical details

	Interaxis 45mm	Interaxis 52mm
Cup type		
Item number		
Item number		
Cup type		
Item number	701.0B08.654.00	
Cup type		
Item number	701.0C78.654.00	701.0C82.654.00
Cup type		
Item number	701.0C54.654.00	701.0C58.654.00

Drilling patterns for hinge cups → see page 9

Cranking
17mm

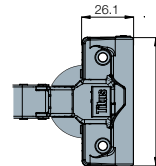
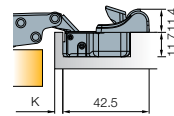
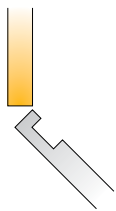

Cup made of steel, arm made of zinc

Mounting plates



Cam adjustable cruciform mounting plate
→ see page 41



Cruciform mounting plate
→ see page 43



Cam adjustable linear mounting plate
→ see page 41



Face frame adapter plate
→ see page 43

Hinge cup screws If not premounted

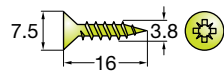

611.8K16.338.016

1,000 Pcs

Accessories



Cover caps for hinge arm
→ see complete catalogue page 1.111

Legend of hinge cup symbols



Screw-on ready
← screws



Machine insertion ready



EasyFix system

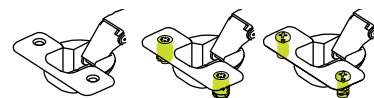

Damping adjustment

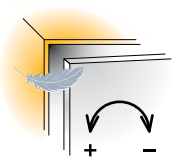

For further explanation → see page 19

Door adjustment

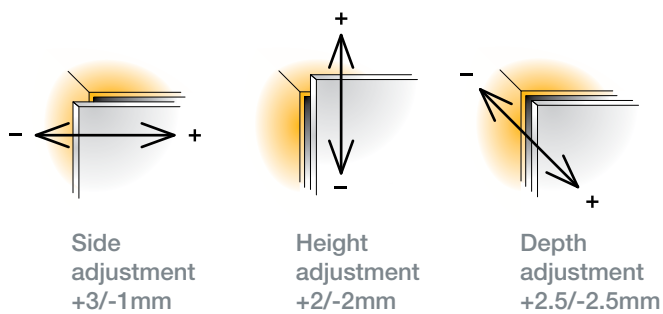

For further explanation → see pages 14-17

Mounting details

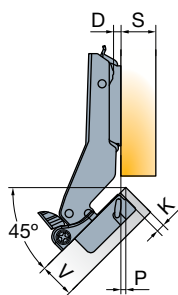
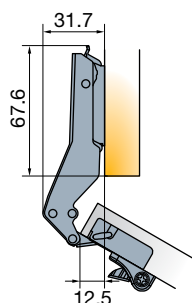

Mounting plate drilling distance

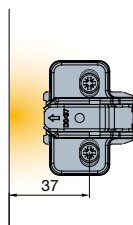

Mounting plate thickness table
For further explanation → see page 5

P	0	0.5	1	1.5	2	2.5	3	3.5	4
3		2		1		0			
4	3		2		1		0		
5		3		2		1		0	
6	4		3		2		1		0 D

Drawings show application on D=0mm thick mounting plate

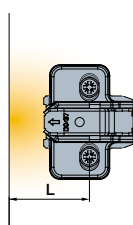
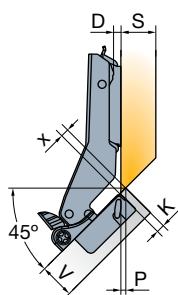
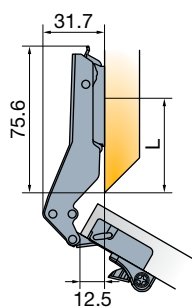

X	0	0.5	1	1.5	2	2.5	3	3.5	4	4.5	5	6
3	2			1			0					
4			2			1			0			
5		3			2			1			0	
6	4			3			2			1		0 D

Drawings show application on D=0mm thick mounting plate

L=45 for thickness D=0
L=44 for thickness D=1
L=43 for thickness D=2
L=42 for thickness D=3
L=41 for thickness D=4

Door clearance at R=1mm
For further explanation → see page 5

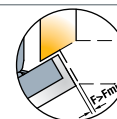

V	16	17	18	19	20	21	22	23	24	25	26
3	0.5	0.7	0.8	1	1.2	1.5	1.7	2.1	2.8	4.1	5.5
4	0.4	0.7	0.8	1	1.2	1.5	1.7	2.1	2.3	3.1	4.5
5	0.4	0.6	0.7	0.9	1.1	1.4	1.6	2	2.2	2.6	3.5
6	0.4	0.6	0.7	0.9	1.1	1.4	1.6	2	2.2	2.6	2.9 F _{MIN}

Gap Z_{MIN}=0

T-type Glissando 110/90°

For wood door cabinets with blind panels

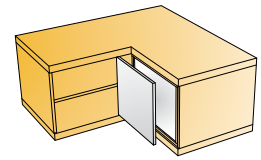
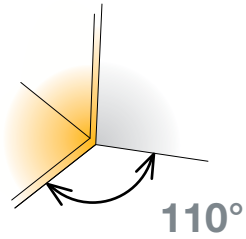

- Opening angle 110°
- Drilling diameter for hinge cup 35mm
- Drilling depth 11.7mm
- Hinge on plate mounting system '3Way' snap-on



Technical details

	Interaxis 45mm	Interaxis 52mm
Cup type		
Item number	701.0A96.654.00	701.0D40.654.00
	701.0D36.654.00	701.0D34.654.00
	701.0D30.654.00	701.0D34.654.00

Cranking 17mm

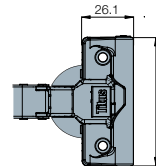
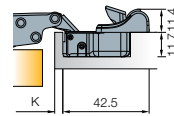

Drilling patterns for hinge cups → see page 9

Cup made of steel, arm made of zinc

Mounting plates



Cam adjustable cruciform mounting plate
→ see page 41



Cruciform mounting plate
→ see page 43



Cam adjustable linear mounting plate
→ see page 41



Face frame adapter plate
→ see page 43

Hinge cup screws

If not premounted

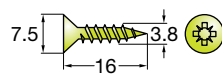

611.8K16.338.016

1,000 Pcs

Accessories



Cover caps for hinge arm
→ see complete catalogue page 1.111

Legend of hinge cup symbols

Screw-on ready
← screws

Machine insertion ready

EasyFix system

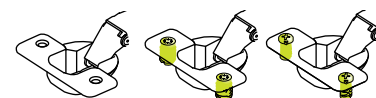

Damping adjustment

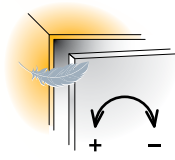

For further explanation → see page 19

Door adjustment

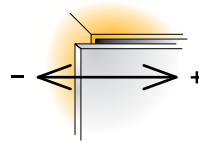

Side adjustment
+3/-1mm

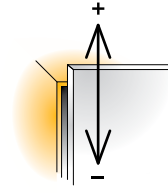

Height adjustment
+2/-2mm

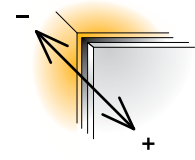

Depth adjustment
+2.5/-2.5mm

For further explanation → see pages 14-17

Mounting details

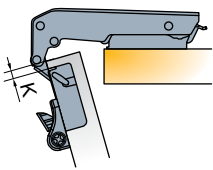

Drawings show application on D=2mm thick mounting plate

Mounting plate drilling distance

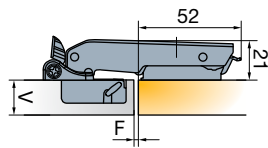

Drawings show application on D=2mm thick mounting plate

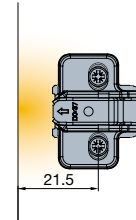

Door clearance at R=1mm

For further explanation → see page 5

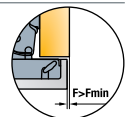

V	16	17	18	19	20	21	22	23	24	25	26	
K	3	0.5	0.7	0.8	1	1.2	1.5	1.7	2.1	2.8	4.1	5.5
	4	0.4	0.7	0.8	1	1.2	1.5	1.7	2.1	2.3	3.1	4.5
	5	0.4	0.6	0.7	0.9	1.1	1.4	1.6	2	2.2	2.6	3.5
	6	0.4	0.6	0.7	0.9	1.1	1.4	1.6	2	2.2	2.6	2.9 F _{MIN}

Gap Z_{MIN}=0

T-type 110

For wood doors

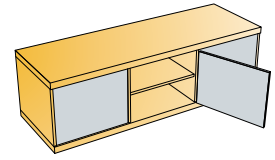
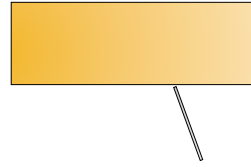
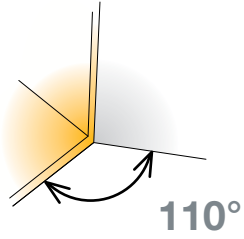

- Opening angle
- Drilling diameter for hinge cup
- Drilling depth
- Hinge on plate mounting system

110°
35mm
11.7mm
'3Way' snap-on



Technical details

Cup type	Interaxis 45mm	Interaxis 52mm
Item number	Item number	Item number
	702.0AK0.054.00	
	702.0AK1.054.00	702.0AM1.054.00
	702.0AK4.054.00	702.0AM4.054.00

Drilling patterns for hinge cups → see page 9

Cranking
0mm

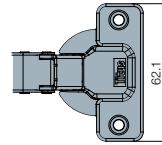
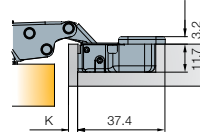
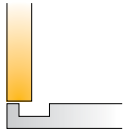

Made of steel

Mounting plates



Cam adjustable cruciform mounting plate
→ see page 41



Cruciform mounting plate
→ see page 43



Cam adjustable linear mounting plate
→ see page 41



Face frame adapter plate
→ see page 43

Hinge cup screws If not premounted

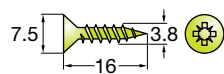

611.8K16.338.016
1,000 Pcs

Accessories



Cover caps for hinge arm
→ see complete catalogue pages 1.111



Push latch
→ see complete catalogue page 1.109

Legend of hinge cup symbols

Screw-on ready
← screws
 Machine insertion ready
 EasyFix system

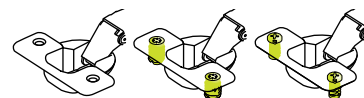

Door adjustment

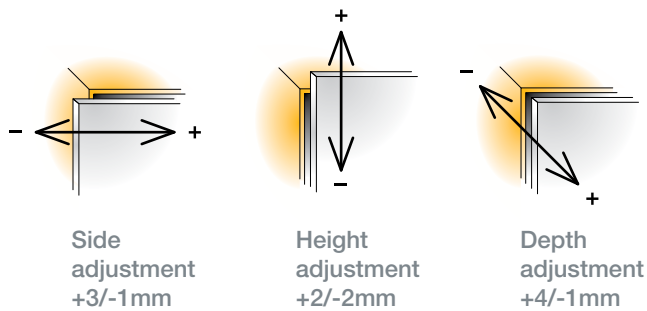

For further explanation → see pages 14-17

Mounting details

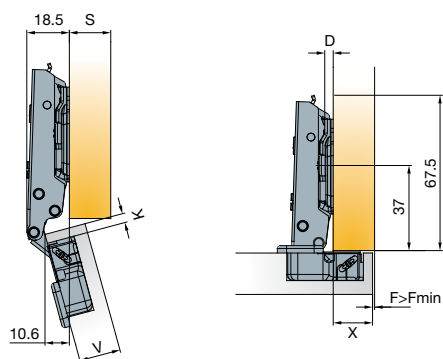

Drawings show application on D=0mm thick mounting plate

Mounting plate drilling distance

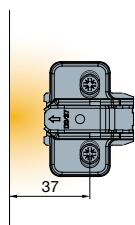

Mounting plate thickness table

For further explanation → see page 5

x	13	14	15	16	17	18	19
3	3	2	1	0			
4	4	3	2	1	0		
K							
5		4	3	2	1	0	
6			4	3	2	1	0
							D

$D=13+K-x$

Soft closing systems



Glissando TL
→ see page 55



Glissando CR
→ see page 59

Door clearance at R=1mm

For further explanation → see page 5

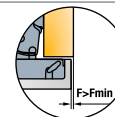

V	16	17	18	19	20	21	22	23	24	25	26
3	0.5	0.7	0.8	1	1.2	1.5	1.7	2.1	2.8	4.1	5.5
4	0.4	0.7	0.8	1	1.2	1.5	1.7	2.1	2.3	3.1	4.5
K											
5	0.4	0.6	0.7	0.9	1.1	1.4	1.6	2	2.2	2.6	3.5
6	0.4	0.6	0.7	0.9	1.1	1.4	1.6	2	2.2	2.6	2.9
											F _{MIN}

Gap Z_{MIN}=0

T-type 110

For wood doors

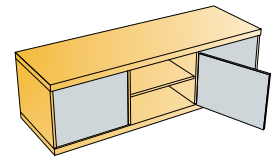
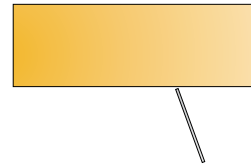
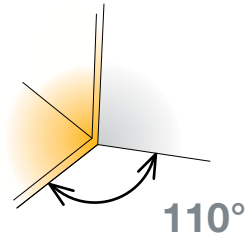

- Opening angle
- Drilling diameter for hinge cup
- Drilling depth
- Hinge on plate mounting system

110°
35mm
11.7mm
'3Way' snap-on



Technical details

Cup type	Interaxis 45mm	Interaxis 52mm
Item number	Item number	Item number
	702.0CK0.054.00	
	702.0CK1.054.00	702.0CM1.054.00
	702.0CK4.054.00	702.0CM4.054.00

Cranking
9mm

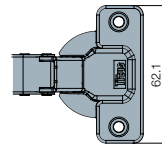
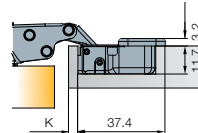
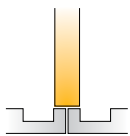

Made of steel

Cranking
17mm

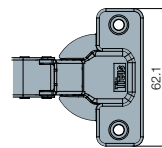
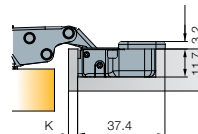
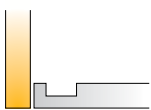

Made of steel

Drilling patterns for hinge cups → see page 9

Drilling patterns for hinge cups → see page 9

Mounting plates

Cam adjustable cruciform mounting plate
→ see page 41

Cruciform mounting plate
→ see page 43

Cam adjustable linear mounting plate
→ see page 41

Face frame adapter plate
→ see page 43

Hinge cup screws

If not premounted

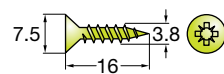

611.8K16.338.016

1,000 Pcs

Accessories

Cover caps for hinge arm
→ see complete catalogue page 1.111

Push latch
→ see complete catalogue page 1.109

Legend of hinge cup symbols

Screw-on ready
← screws

Machine insertion ready

EasyFix system

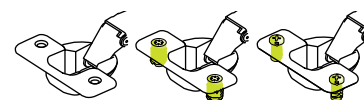

Door adjustment

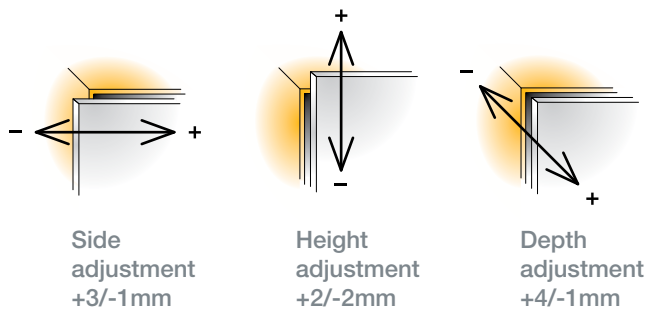

For further explanation → see pages 14-17

Mounting details

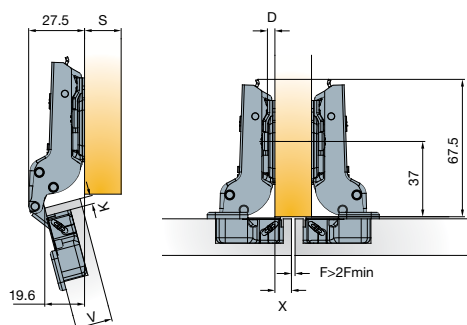

Drawings show application on D=0mm thick mounting plate

Mounting plate drilling distance

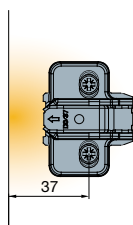

Mounting plate thickness table
For further explanation → see page 5

x	4	5	6	7	8	9	10
3	3	2	1	0			
4	4	3	2	1	0		
5		4	3	2	1	0	
6			4	3	2	1	0

$D=4+K \cdot x$

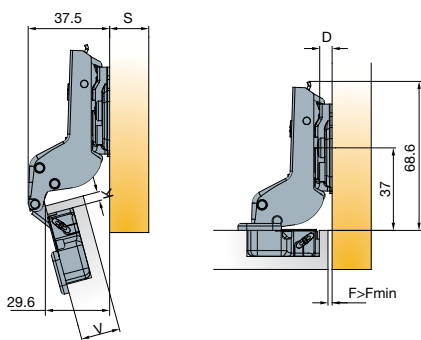

Drawings show application on D=2mm thick mounting plate

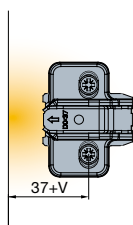

V	16	17	18	19	20	21	22	23	24
3	0	0	0	0	1	1	1	1	2
4	1	1	1	1	2	2	2	2	3
5	2	2	2	2	3	3	3	3	4
6	3	3	3	3	4	4	4	4	D

$D=4+K+F$

Soft closing systems



Glissando TL
→ see page 55



Glissando CR
→ see page 59

Door clearance at R=1mm

For further explanation → see page 5

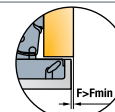

V	16	17	18	19	20	21	22	23	24	25	26
3	0.5	0.7	0.8	1	1.2	1.5	1.7	2.1	2.8	4.1	5.5
4	0.4	0.7	0.8	1	1.2	1.5	1.7	2.1	2.3	3.1	4.5
5	0.4	0.6	0.7	0.9	1.1	1.4	1.6	2	2.2	2.6	3.5
6	0.4	0.6	0.7	0.9	1.1	1.4	1.6	2	2.2	2.6	2.9 F _{MIN}

Gap Z_{MIN}=0

T-type 110/45°

45° angled application for wood doors

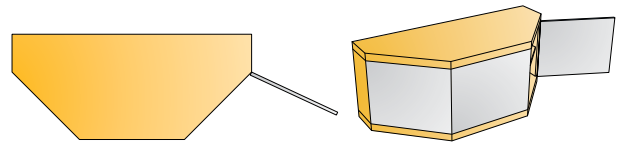
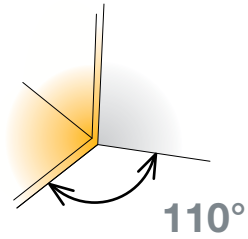

- Opening angle 110°
- Drilling diameter for hinge cup 35mm
- Drilling depth 11.7mm
- Hinge on plate mounting system '3Way' snap-on



Technical details

	Interaxis 45mm	Interaxis 52mm
Cup type		
Item number		
Item number		
Cup type		
Item number	702.0B07.654.00	
Cup type		
Item number	702.0C77.654.00	702.0C81.654.00
Cup type		
Item number	702.0C53.654.00	702.0C57.654.00

Cranking 17mm

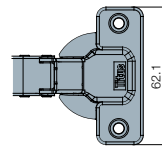
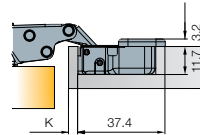
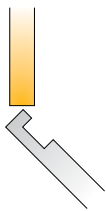

Drilling patterns for hinge cups → see page 9

Cup made of steel, arm made of zinc

Mounting plates



Cam adjustable cruciform mounting plate
→ see page 41



Cruciform mounting plate
→ see page 43



Cam adjustable linear mounting plate
→ see page 41



Face frame adapter plate
→ see page 43

Hinge cup screws

If not premounted

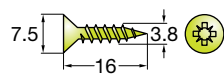

611.8K16.338.016

1,000 Pcs

Accessories



Cover caps for hinge arm
→ see complete catalogue page 1.111

Legend of hinge cup symbols



Screw-on ready
← screws



Machine insertion ready



EasyFix system

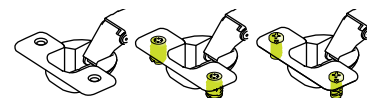

Door adjustment

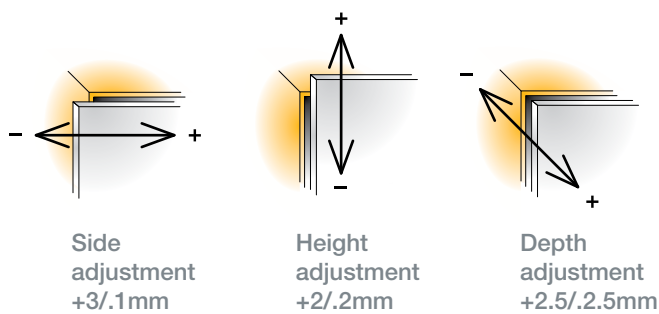

For further explanation → see pages 14-17

Mounting details

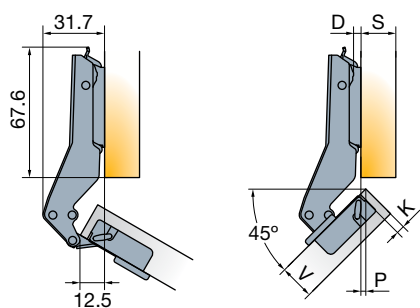

Drawings show application on D=0mm thick mounting plate

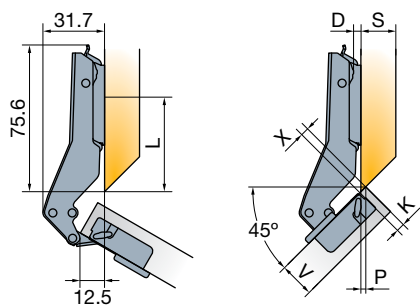

Drawings show application on D=0mm thick mounting plate

Mounting plate drilling distance

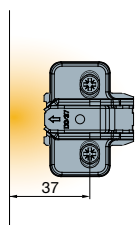

Mounting plate thickness table
For further explanation → see page 5

P	0	0.5	1	1.5	2	2.5	3	3.5	4
3		2		1		0			
4	3		2		1		0		
5		3		2		1		0	
6	4		3		2		1		0 D

X

X	0	0.5	1	1.5	2	2.5	3	3.5	4	4.5	5	6
3	2			1			0					
4			2			1			0			
5		3			2			1			0	
6	4			3			2			1		0 D

L=45 for thickness D=0
 L=44 for thickness D=1
 L=43 for thickness D=2
 L=42 for thickness D=3
 L=41 for thickness D=4

Soft closing systems



Glissando TL
→ see page 55



Glissando CR
→ see page 59

Door clearance at R=1mm

For further explanation → see page 5

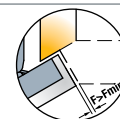

V	16	17	18	19	20	21	22	23	24	25	26
3	0.5	0.7	0.8	1	1.2	1.5	1.7	2.1	2.8	4.1	5.5
4	0.4	0.7	0.8	1	1.2	1.5	1.7	2.1	2.3	3.1	4.5
5	0.4	0.6	0.7	0.9	1.1	1.4	1.6	2	2.2	2.6	3.5
6	0.4	0.6	0.7	0.9	1.1	1.4	1.6	2	2.2	2.6	2.9 F _{MIN}

Gap Z_{MIN}=0

T-type 110/90°

For wood door cabinets with blind panels

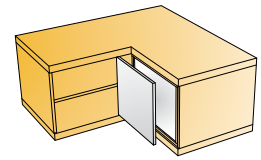
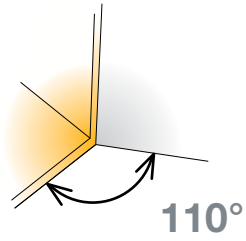

- Opening angle 110°
- Drilling diameter for hinge cup 35mm
- Drilling depth 11.7mm
- Hinge on plate mounting system '3Way' snap-on



Technical details

	Interaxis 45mm	Interaxis 52mm
Cup type		
Item number		
	702.0A95.654.00	
	702.0D35.654.00	702.0D39.654.00
	702.0D29.654.00	702.0D33.654.00

Cranking
17mm

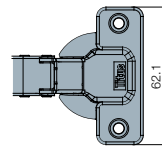
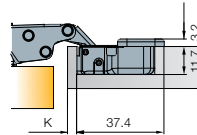

Drilling patterns for hinge cups → see page 9

Cup made of steel, arm made of zinc

Mounting plates



Cam adjustable cruciform mounting plate
→ see page 41



Cruciform mounting plate
→ see page 43



Cam adjustable linear mounting plate
→ see page 41



Face frame adapter plate
→ see page 43

Hinge cup screws

If not premounted

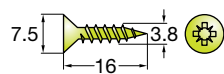

611.8K13.338.016

1,000 Pcs

Accessories



Cover caps for hinge arm
→ see complete catalogue page 1.111

Legend of hinge cup symbols



Screw-on ready
← screws



Machine insertion ready



EasyFix system

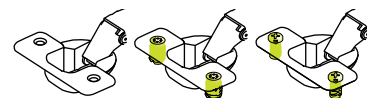

Door adjustment

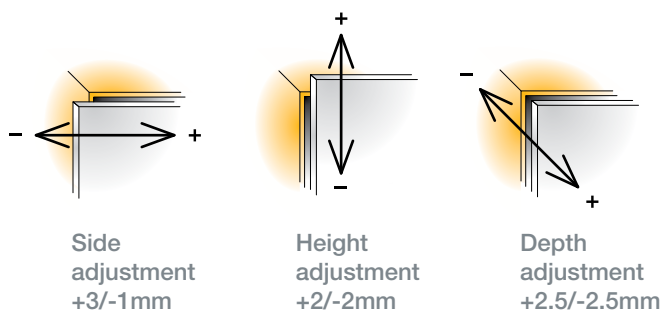

For further explanation → see pages 14-17

Mounting details

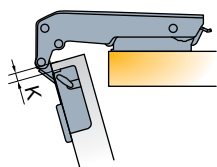

Drawings show application on D=2mm thick mounting plate

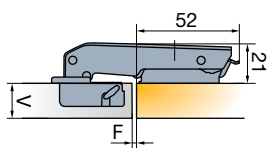

Drawings show application on D=2mm thick mounting plate

Mounting plate drilling distance

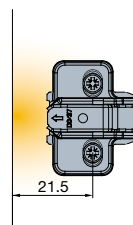

Soft closing systems



Glissando TL
→ see page 55



Glissando CR
→ see page 59

Door clearance at R=1mm

For further explanation → see page 5

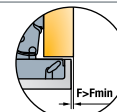

V	16	17	18	19	20	21	22	23	24	25	26	
3	0.5	0.7	0.8	1	1.2	1.5	1.7	2.1	2.8	4.1	5.5	
4	0.4	0.7	0.8	1	1.2	1.5	1.7	2.1	2.3	3.1	4.5	
K	5	0.4	0.6	0.7	0.9	1.1	1.4	1.6	2	2.2	2.6	3.5
6	0.4	0.6	0.7	0.9	1.1	1.4	1.6	2	2.2	2.6	2.9	F _{MIN}

Gap Z_{MIN}=0

T-type 170

For wood doors

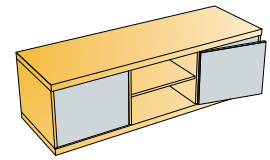
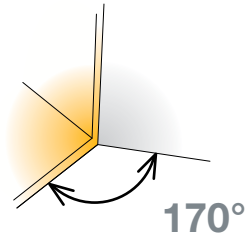

- Opening angle
- Drilling diameter for hinge cup
- Drilling depth
- Hinge on plate mounting system

165°
35mm
12mm
'3Way' snap-on



Cup type	Interaxis 45mm	Interaxis 52mm
	Item number	Item number
	702.0EK0.054.00	
	702.0EK1.054.00	702.0EM1.054.00
	702.0EK4.054.00	702.0EM4.054.00

Cranking
0mm

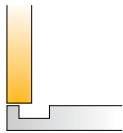

Drilling patterns for hinge cups → see page 9

Made of steel and zinc

Mounting plates



Cam adjustable cruciform mounting plate
→ see page 41



Cruciform mounting plate
→ see page 43



Cam adjustable horizontal mounting plate
→ see page 41



Face frame adapter plate
→ see page 43

Hinge cup screws If not Premounted

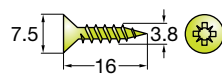

611.8K16.338.016

1,000 Pcs

Accessories



Push latch
→ see page 1.150

Legend of hinge cup symbols

Screw-on ready
← screws

Machine insertion ready

EasyFix system

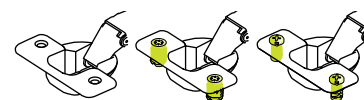

Door adjustment

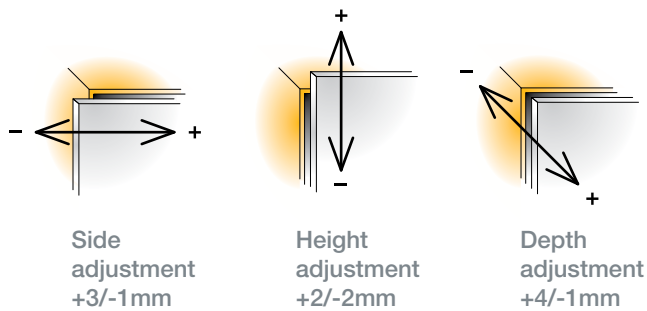

For further explanation → see pages 14-17

Mounting details

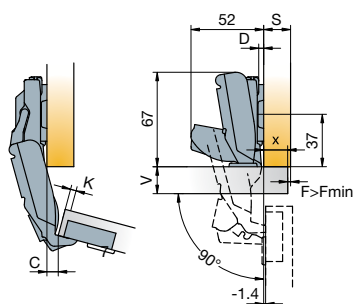

Drawings show application on D=0mm mounting plate
In 90° position the door is only 1.4mm distant from side panel

Mounting plate drilling distance

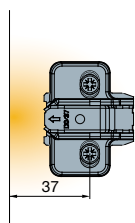

Mounting plate thickness table

For further explanation → see page 5

x	13	14	15	16	17	18	19
3	3	2	1	0			
4	4	3	2	1	0		
K							
5		4	3	2	1	0	
6			4	3	2	1	0
							D

$D=13+K-x$

Soft closing systems



Glissando TL 170
→ see page 57



Glissando CR
→ see page 59

Door clearance at R=1mm

For further explanation > see page 5

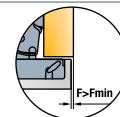

V	16	17	18	19	20	21	22	23	24
3	0.0	0.0	0.0	0.0	0.0	0.0	0.0	0.0	0.0
4	0.0	0.0	0.0	0.0	0.0	0.0	0.0	0.0	0.0
K									
5	0.0	0.0	0.0	0.0	0.0	0.0	0.0	0.0	0.0
6	0.0	0.0	0.0	0.0	0.0	0.0	0.0	0.0	2.6
7	0.0	0.0	0.0	0.0	0.0	0.0	0.0	0.0	5.1

Gap Z_{MIN}=0.5

T-type 170

For wood doors

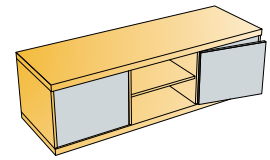
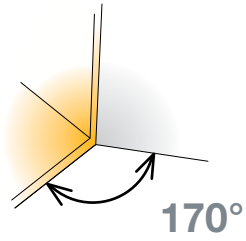

- Opening angle
- Drilling diameter for hinge cup
- Drilling depth
- Hinge on plate mounting system

- 165°
- 35mm
- 12mm
- '3Way' snap-on



Cranking
9mm

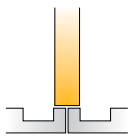

	Interaxis 45mm	Interaxis 52mm
Cup type	Item number	Item number
	702.0GK0.054.00	
	702.0GK1.054.00	702.0GM1.054.00
	702.0GK4.054.00	702.0GM4.054.00

Drilling patterns for hinge cups → see page 9

Made of steel and zinc

Mounting plates

- Cam adjustable cruciform mounting plate
→ see page 41
- Cruciform mounting plate
→ see page 43
- Cam adjustable horizontal mounting plate
→ see page 41
- Face frame adapter plate
→ see page 43

Hinge cup screws

If not Premounted

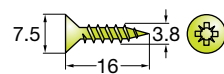

611.8K16.338.016

1,000 Pcs

Accessories



Push latch

→ see complete catalogue page 1.109

Legend of hinge cup symbols

- Screw-on ready < screws
- Machine insertion ready
- EasyFix system

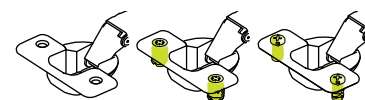

Door adjustment

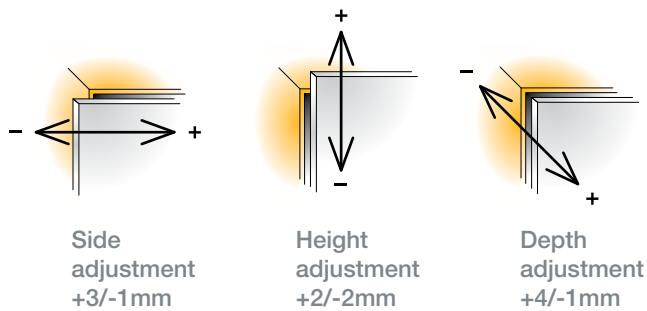

For further explanation > see pages 14-17

Mounting details

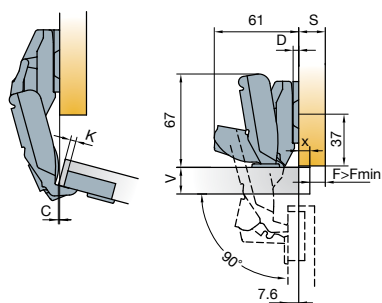

Drawings show application on D=0mm thick mounting plate

Mounting plate drilling distance

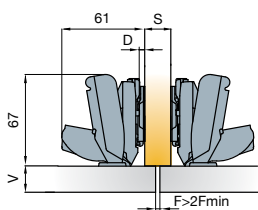

Drawings show application on D=0mm thick mounting plate

Mounting plate thickness table

For further explanation > see page 5

x	13	14	15	16	17	18	19
K	3	3	2	1	0		
	4	4	3	2	1	0	
	5		4	3	2	1	0
	6			4	3	2	1

$D=13+K-x$

Soft closing systems



Glissando TT 170 > see page 61

Glissando CR > see page 65

Door clearance at R=1mm

For further explanation > see page 5

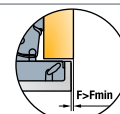

V	16	17	18	19	20	21	22	23	24
3	0.0	0.0	0.0	0.0	0.0	0.0	0.0	0.0	0.0
	0.0	0.0	0.0	0.0	0.0	0.0	0.0	0.0	0.0
K 5	0.0	0.0	0.0	0.0	0.0	0.0	0.0	0.0	0.0
	0.0	0.0	0.0	0.0	0.0	0.0	0.0	0.0	2.6
7	0.0	0.0	0.0	0.0	0.0	0.0	0.0	0.0	5.1

Gap Z_{MIN}=0.5

T-type Mounting Plates

'3Way' snap-on mounting

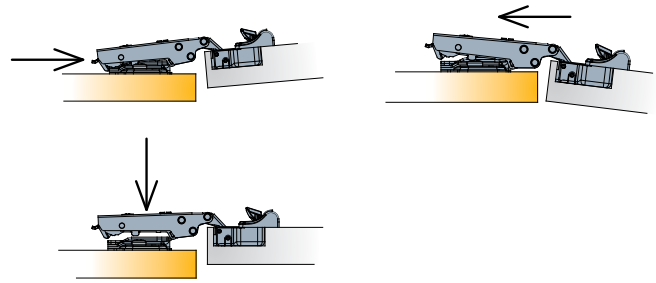

Cam adjustable cruciform
mounting plate 37mm

Drilling pattern

Dimensions

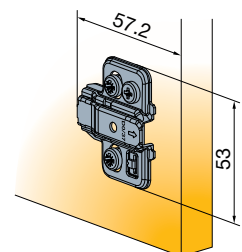
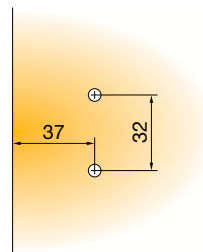

Made of steel

Cam adjustable linear
mounting plate

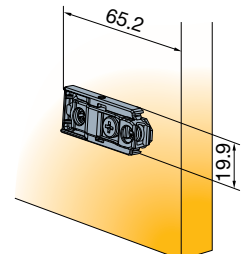
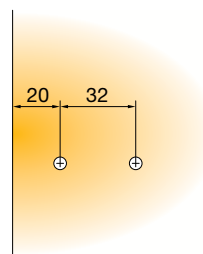

Made of steel and zinc

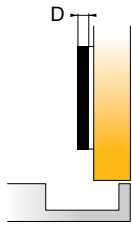

Mounting plate thickness

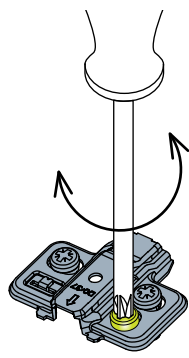

Height adjustment +2/-2mm

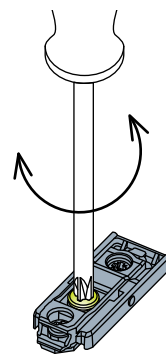

Height adjustment +2/-2mm

Mounting plate type	15		10.5	
Mounting plate thickness (D)				
	Item number	Item number	Item number	
0mm	700.0KC0.054.00	700.0KB0.054.00	700.0KF0.054.00	
1mm	700.0KC1.054.00	700.0KB1.054.00	700.0KF1.054.00	
2mm	700.0KC2.054.00	700.0KB2.054.00	700.0KF2.054.00	
3mm	700.0KC3.054.00	700.0KB3.054.00	700.0KF3.054.00	
4mm	700.0KC4.054.00	700.0KB4.054.00	700.0KF4.054.00	
0mm	700.0LC0.054.00	700.0LB0.054.00	700.0LF0.054.00	
2mm	700.0LC2.054.00	700.0LB2.054.00	700.0LF2.054.00	
3mm	700.0LC3.054.00	700.0LB3.054.00	700.0LF3.054.00	

Legend of mounting plate type symbols



Premounted 15mm euro screws

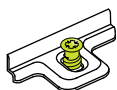

Machine insertion ready

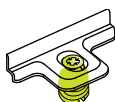

Premounted 10.5mm expanding dowels

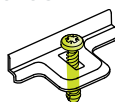

T-type Mounting Plates

'3Way' snap-on mounting

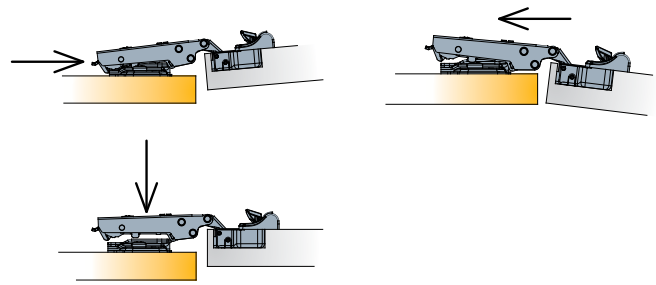

Cruciform mounting plate 37mm

Drilling pattern

Dimensions



Made of steel

Face frame mounting plate

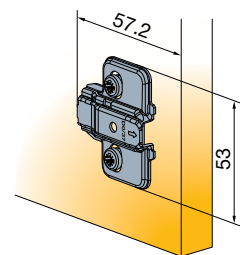
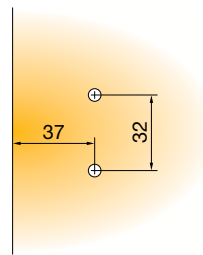

Made of steel and zinc

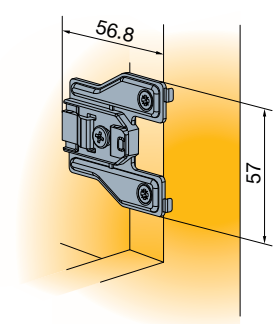
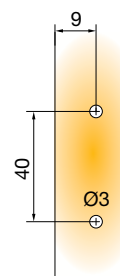

Fixing screw for cruciform mounting plate
If not premounted

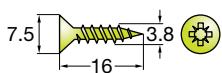

Chipboard screws
820.6328.050

1,000 Pcs

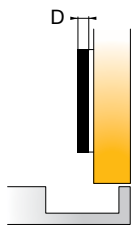



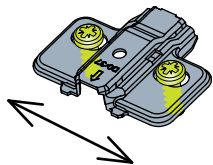

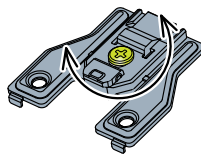

Mounting plate thickness







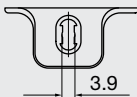
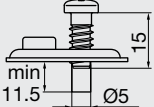
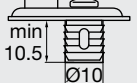
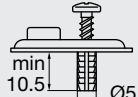

Height adjustment +2/-2mm



Height adjustment +2/-2mm

Mounting plate type		 15		 10.5	
Mounting plate thickness (D)					
Item number	Item number	Item number	Item number	Item number	Item number
0mm	700.0NA0.054.00	700.0NC0.054.00	700.0NB0.054.00	700.0NF0.054.00	
1mm	700.0NA1.054.00	700.0NC1.054.00	700.0NB1.054.00	700.0NF1.054.00	
2mm	700.0NA2.054.00	700.0NC2.054.00	700.0NB2.054.00	700.0NF2.054.00	
3mm	700.0NA3.054.00	700.0NC3.054.00	700.0NB3.054.00	700.0NF3.054.00	
4mm	700.0NA4.054.00	700.0NC4.054.00	700.0NB4.054.00	700.0NF4.054.00	
0mm					700.0NW0.054.00
3mm					700.0NW3.054.00

Legend of mounting plate type symbols

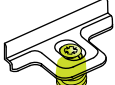
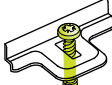
	 15		 10.5
Screw-on ready for chipboard screws ← screws	Premounted 15mm euro screws	Machine insertion ready	Premounted 10.5mm expanding dowels
			

Glissando

Soft Closing Range

How to Choose the Right Glissando

Glissando TT
 Glissando TT 170
 Glissando CR

Titus Glissando soft closing system is available for the whole range of hinge applications. The user can choose between add-on hinge or stand-alone solutions.

Concealed hinges	Add-on hinge soft closing solutions		Stand-alone door soft closing solution
	Glissando TT	Glissando TT 170	Glissando CR
T-type 110	X		X
T-type 110/45°	X		X
T-type 110/90°	X		X
T-type 170		X	

Glissando Application

Glissando TT 'one for all'

T-type

- One item fits multiple applications
- Same item can be used on all crankings and angled hinges
- Adjustable damping enables perfect functioning on every door
- Designed to fit the concealed hinge cup
- Toolless mounting
- Suitable for different types of cabinets for kitchens, living rooms, bathrooms and other furniture

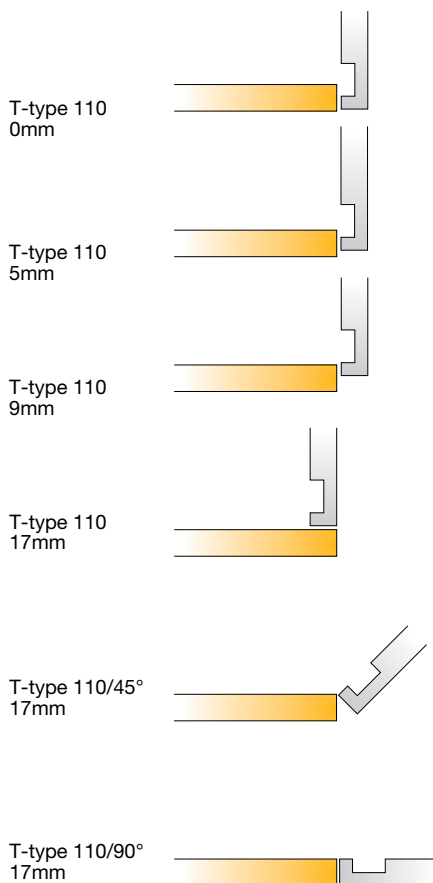
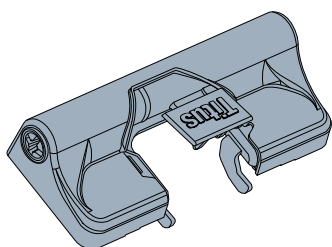

Glissando

Number per Door and Positioning

How Many Glissandos per Door

Add-on hinge soft closing solution

- Glissando TT
- Glissando TT 170

Mount Glissando on the bottom hinge if 2 hinges on the door or on the middle hinge in case of if 3 hinges on the door.

T-type

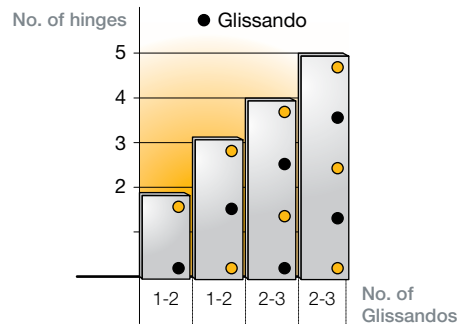

Recommended number per door and positioning

S-type, B-type

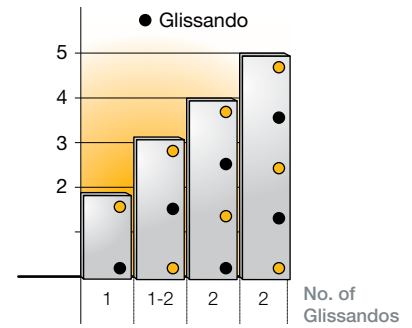

Recommended number per door and positioning



Titus Glissando soft closing devices can not be used with free-swinging door hinges.

How Many Glissandos per Door

Stand-alone soft closing solution

- Glissando CR

Mount a CR on the hinged side of the cabinet on the top or bottom.

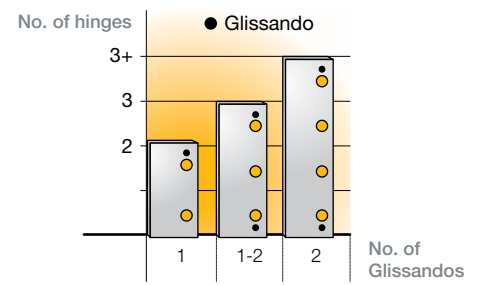

Recommended number per door and positioning

Glissando Mounting

How to Mount Glissando

Toolless mounting

- Glissando TT
- Glissando TT 170

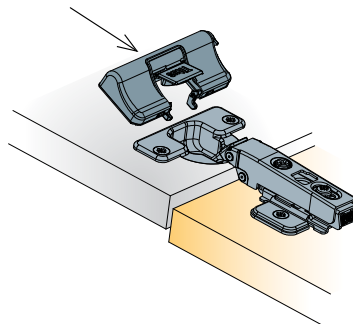

Simple toolless assembly: Insert Glissando into the holes on the hinge and press down with hand.

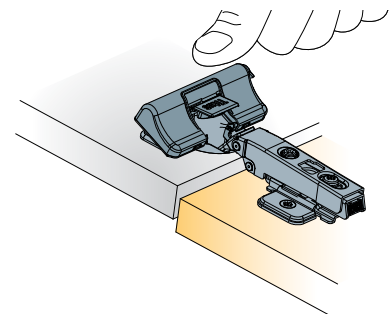

The toolless snap on version for reduced assembly time and flexibility of application; Glissando TT can be mounted at any time after furniture assembly so can be offered as a retro fit option by the installer.

Screw-on into the cabinet corner

- Glissando CR

Glissando CR is mounted into the cabinet corner by using chipboard screws 20mm long.

Glissando dampers' discreet design enhances the look of the door and occupies minimal space in the cabinet interior.

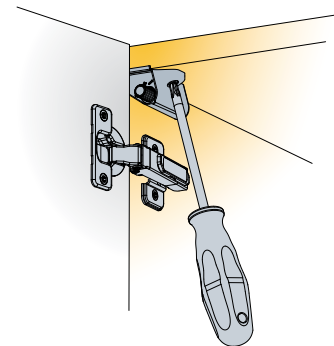

Glissando

Damping Adjustment

How to Adjust Damping?

Add-on hinge soft closing solution

- Glissando TT
- Glissando TT 170

Glissando features quarter turn adjustment to provide optimal closing speed for any door dimensions and weight.

The damping function can be adjusted to fit different door weights which enables

- perfect door functioning
- use of the same type of Glissando for various doors

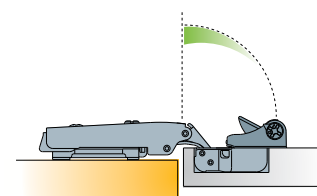

Adjustable damping zone

S-type, B-type

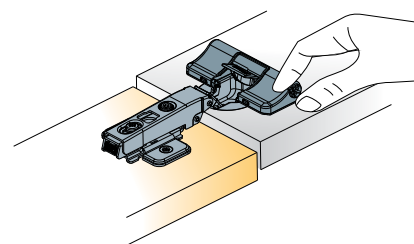

Turn towards '+' to increase and '-' to decrease the damping

Stand-alone soft closing solution

- Glissando CR

Turn towards '+' to increase or towards '-' to decrease the damping.

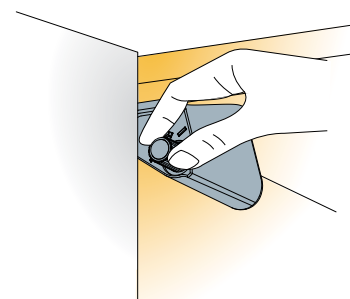

Titus Hydraulic Damper

Efficient modular design

- Low number of assembly parts enables quick development of customised solutions
- Engineered for efficient and high precision manufacturing
- Wide range of applications



Wide operating scope

- High coefficient γ of Titus damper assures efficient damping at any closing speed
- Damping force can be easily adapted to customer needs

$$\gamma = \frac{F_H}{F_L}$$

F_H – damping force at slam speed (12mm/s)

F_L – damping force at slow speed (1mm/s)

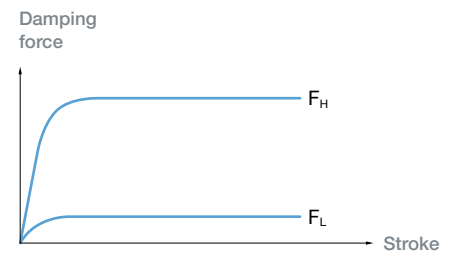

Reliable damping and closing at any speed

Higher coefficient γ means reliable damping at high speed and ensures that the system will reach its final position even at very slow speed



Glissando Soft Closing Systems for Hinges

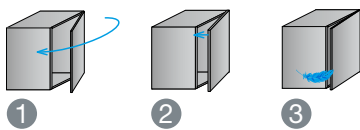

'ConfidentClose'

- 1 Fast closing
- 2 Late start of deceleration action
- 3 Quiet landing with 'SoftTouch'

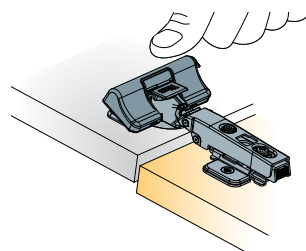

Toolless mounting

- Reduced assembly time
- Flexible usage allows a retrofit installation option

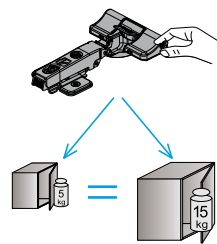

Adjustable damping

- Consistent performance across a broad range of furniture doors of different dimensions and weights



Easy toolless adjustment

- Intuitive adjustment procedure
- Controlable motion

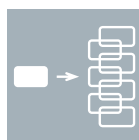

'One for all'

- One item fits multiple applications
- Same item can be used on all crankings and angled hinges



'Titus Damper Inside'

- Titus proprietary multi-purpose damping technology
- Reliable and consistent damping

Glissando TT

Add-on Hinge Soft Closing Solution

For 110° hinges

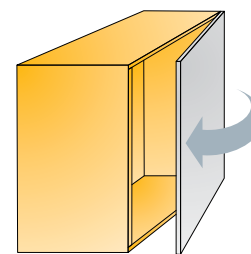
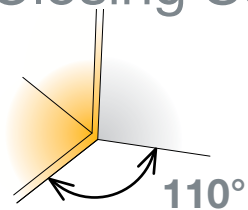

Technical details

Glissando TT snap-on
· T-type 110

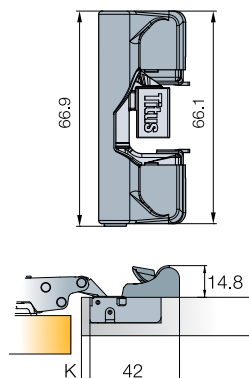

Hinge opening angle

Item number

110°

729.0K71.054.00

Made of steel and plastic

- Same item can be used on all crankings and angled hinges
- Designed to fit the concealed hinge cup and requires no extra space inside the cabinet
- Adjustable damping
- Toolless mounting

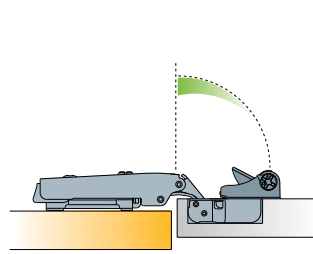

Adjustable damping zone

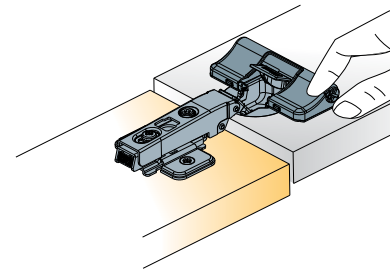

Turn towards '+' to increase and '-' to decrease the damping

Mounting details

Toolless assembly

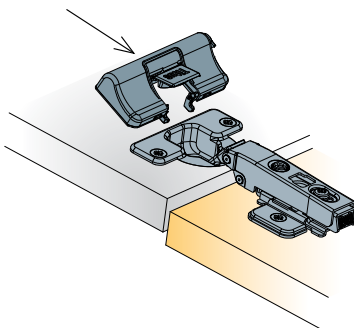

Insert Glissando TT into the holes on the hinge

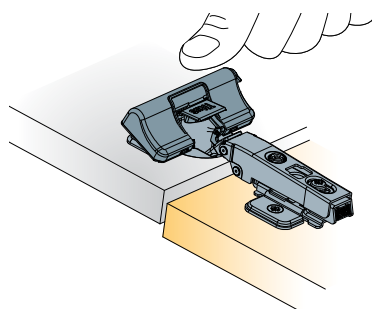

Press down

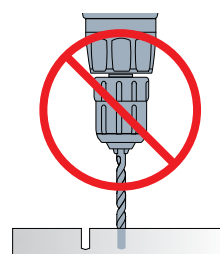
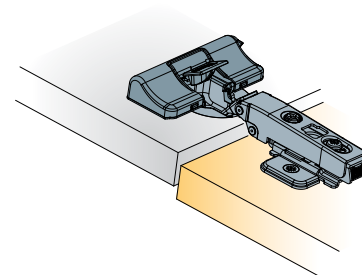

No additional drilling is required

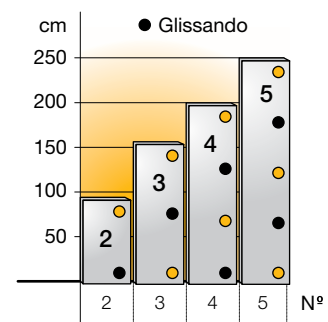

Recommended number per door and positioning

Glissando TT 170

Add-on Hinge Soft Closing Solution

For T-type 170

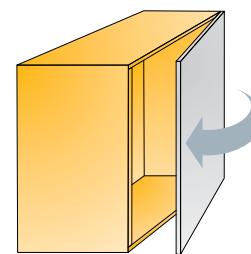

Technical details

Hinge opening angle

Item number

Glissando TT 170 snap-on

110°

951.0F15.650.00



Soft closing mechanism

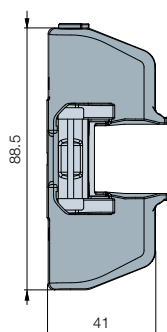

Box contents

- Soft closing mechanism
- Striking plates



Striking plate

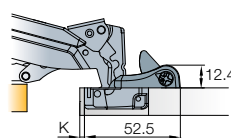

Made of steel and plastic